

EXEGESIS



EXEGESIS



Observation



What Do I See?

Interpretation



What Does It Mean ?

INTERPRETATION

A photograph of a fountain with water spraying upwards, framed by a window with a tree branch visible above it. The fountain is the central focus, with water cascading down its sides. The background is filled with lush green foliage. The window frame is visible on the left and right sides, and a tree branch hangs over the top left corner of the scene.

**Seeking the Author's
Willed Meaning**

INTERPRETATION

1. Text

2. Word Studies

3. Structural Analysis

Thinking God's Thoughts

GRAMMATICAL ANALYSIS

➤ Basic Analysis

BASIC ANALYSIS

- 1. Isolate Complete Sentences**
- 2. Identify Clauses**
- 3. Identify Subjects & Verbs**
- 4. Other Grammatical Issues**

BASIC ANALYSIS

**And after He had said these things,
He was lifted up
while they were looking on,
and a cloud received Him out of
their sight.**

(Act 1:9)

BASIC ANALYSIS

**And after He had said these things,
He was lifted up
while they were looking on,
and a cloud received Him out of
their sight.**

(Act 1:9)

BASIC ANALYSIS

- 1. Isolate Complete Sentences**
- 2. Identify Clauses**

BASIC ANALYSIS

**And after He had said these things,
He was lifted up
while they were looking on,
and a cloud received Him out of
their sight.**

(Act 1:9)

BASIC ANALYSIS

And after He had said these things,

He was lifted up

while they were looking on,

**and a cloud received Him out of
their sight.**

(Act 1:9)

BASIC ANALYSIS

And after He had said these things,

He was lifted up

while they were looking on,

**and a cloud received Him out of
their sight.**

(Act 1:9)

BASIC ANALYSIS

- 1. Isolate Complete Sentences**
- 2. Identify Clauses**
- 3. Identify Subjects & Verbs**

BASIC ANALYSIS

And after He had said these things,

He was lifted up

while they were looking on,

**and a cloud received Him out of
their sight.**

(Act 1:9)

BASIC ANALYSIS

And after He had said these things,

He was lifted up

while they were looking on,

**and a cloud received Him out of
their sight.**

(Act 1:9)

BASIC ANALYSIS

- 1. Isolate Complete Sentences**
- 2. Identify Clauses**
- 3. Identify Subjects & Verbs**
- 4. Other Grammatical Issues**

BASIC ANALYSIS

And after He had said these things,

He was lifted up

while they were looking on,

**and a cloud received Him out of
their sight.**

(Act 1:9)

GRAMMATICAL ANALYSIS

➤ Basic Analysis

➤ Mechanical Layout

MECHANICAL **LAYOUT**

**Rewrite the text in a form
that will reveal the
grammatical structure**

MECHANICAL LAYOUT

Independent Clauses

Subordinate Clauses

Modifiers - ptcp, preps, etc

Lists

Coordinate Clauses

GRAMMATICAL ANALYSIS

- Basic Analysis
- Mechanical Layout
- Diagramming

DIAGRAMMING

**Graphically portray each
word of the sentence**



Lots of letters & words

Isolate Complete Sentences



Identify Clauses

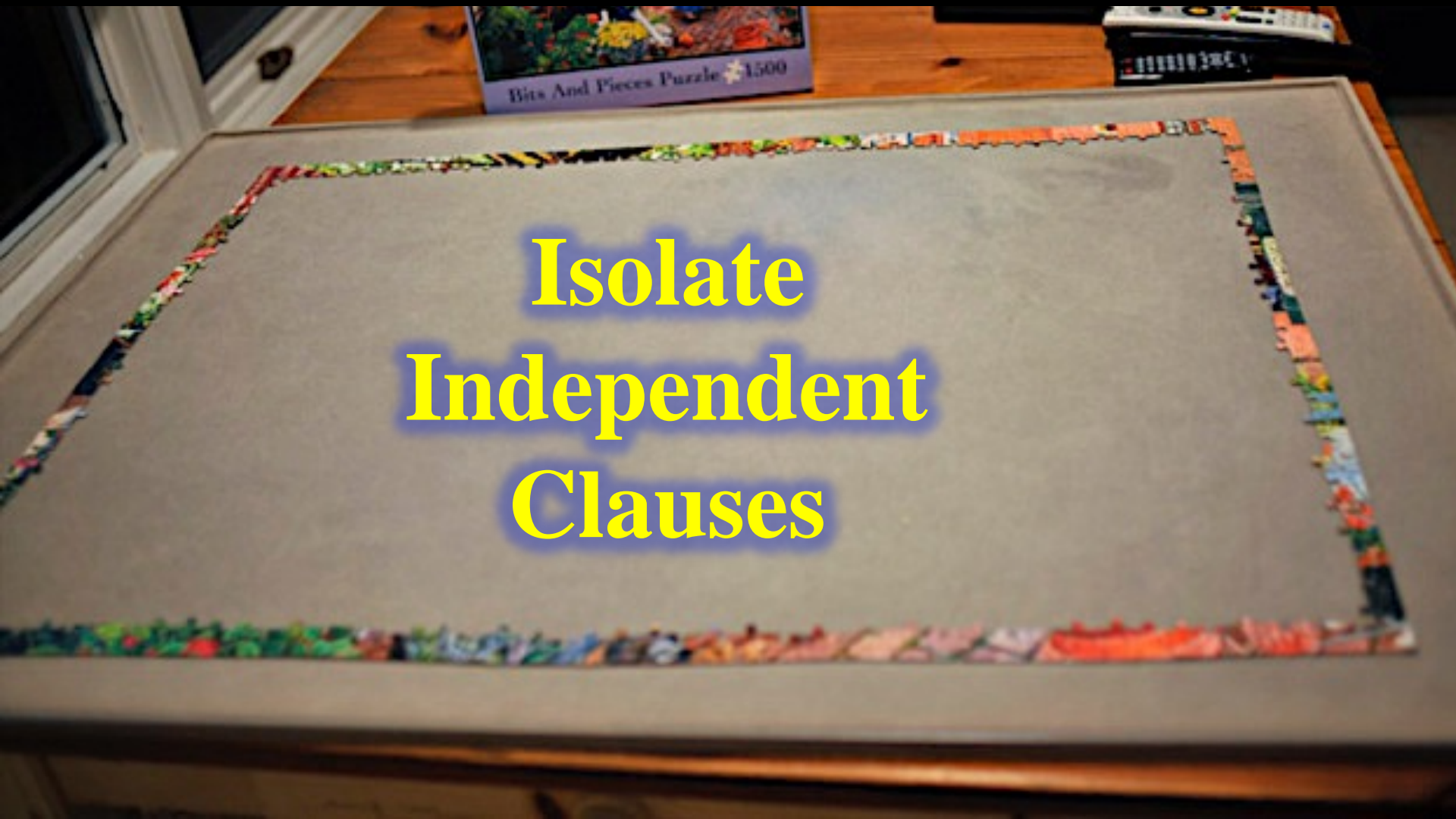

Isolate
Independent
Clauses

Find Subject & Verb



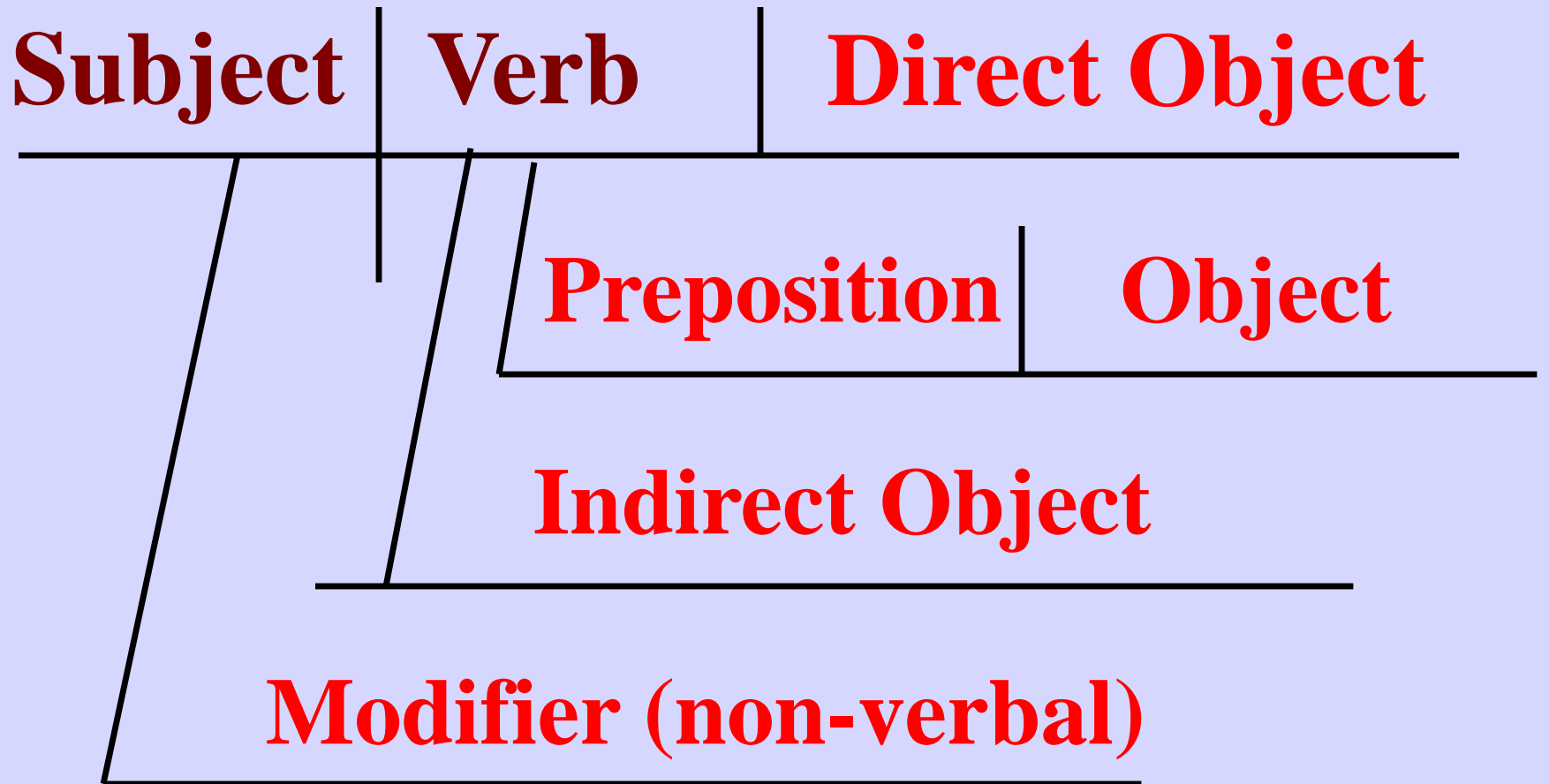

Find Word Relationships



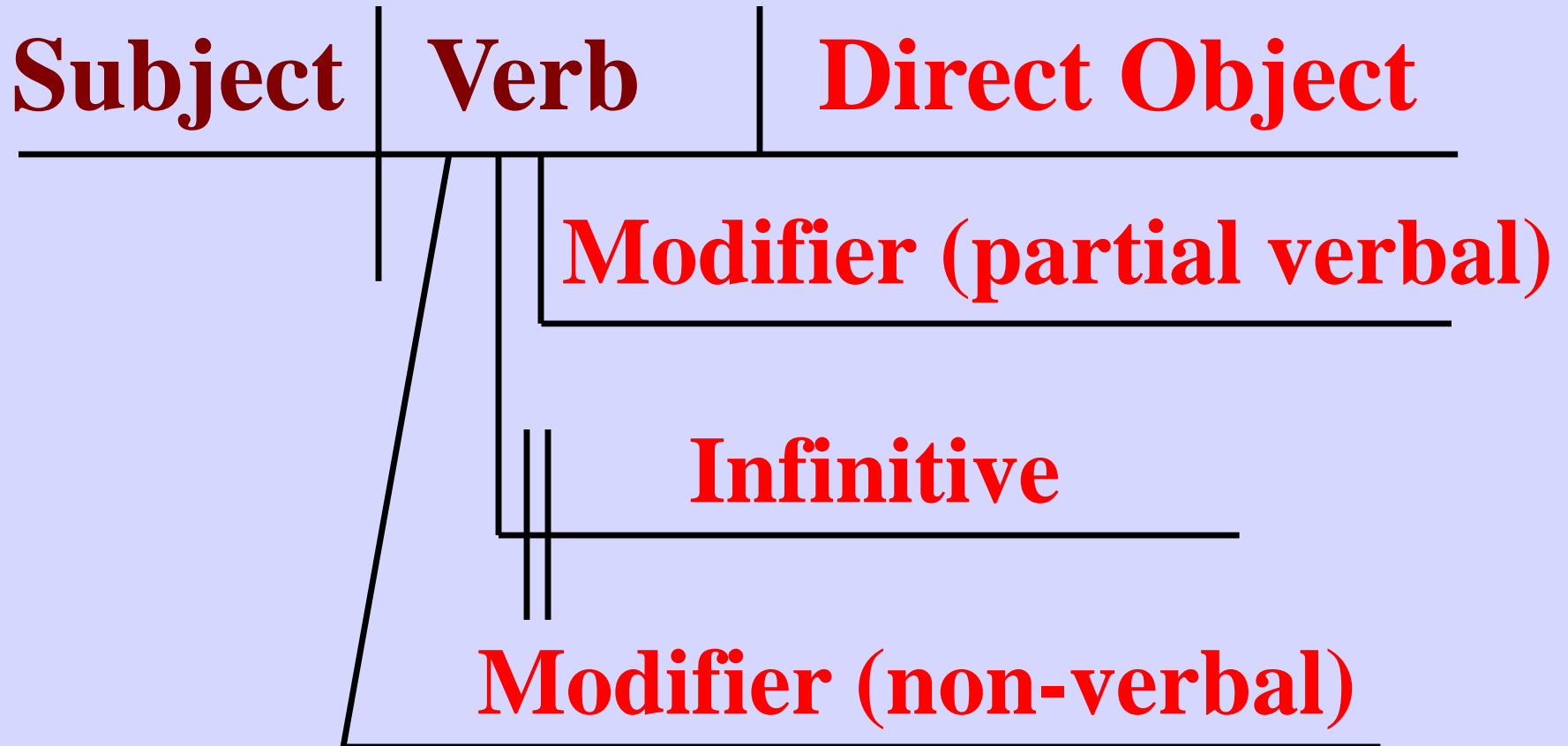

Subject

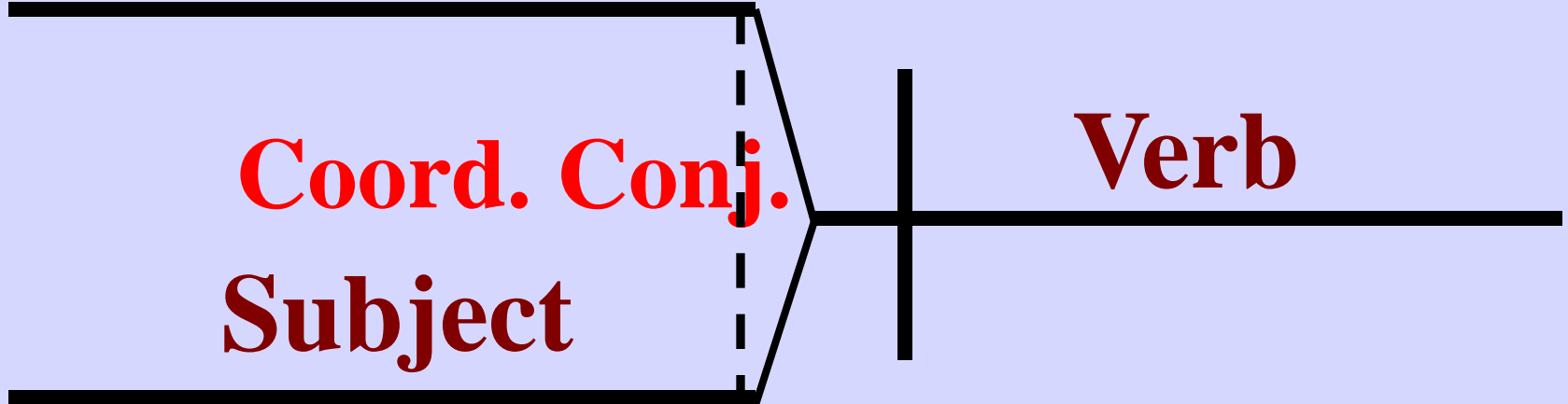

Term = **Appositive**

Subordinate Clauses



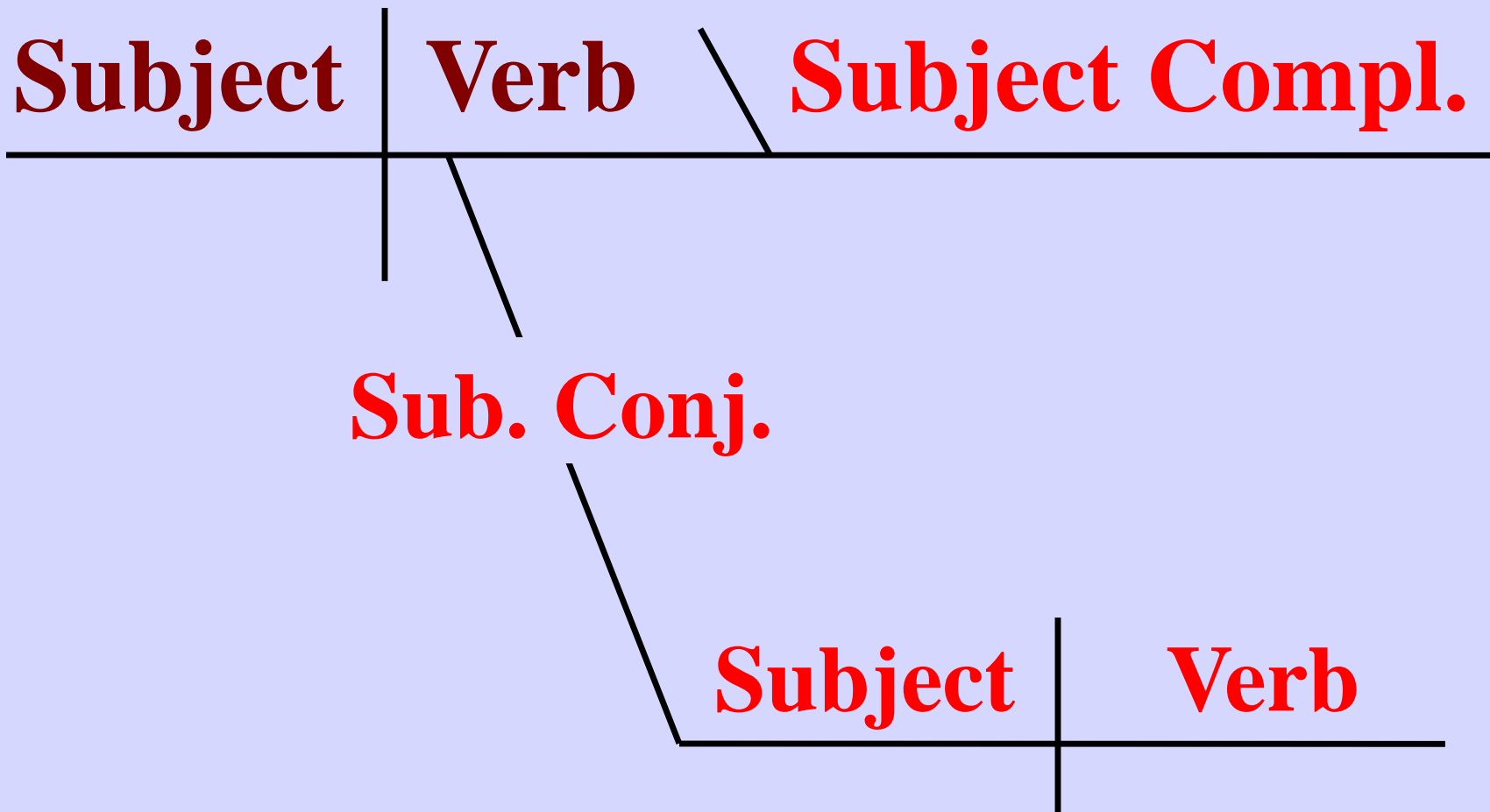

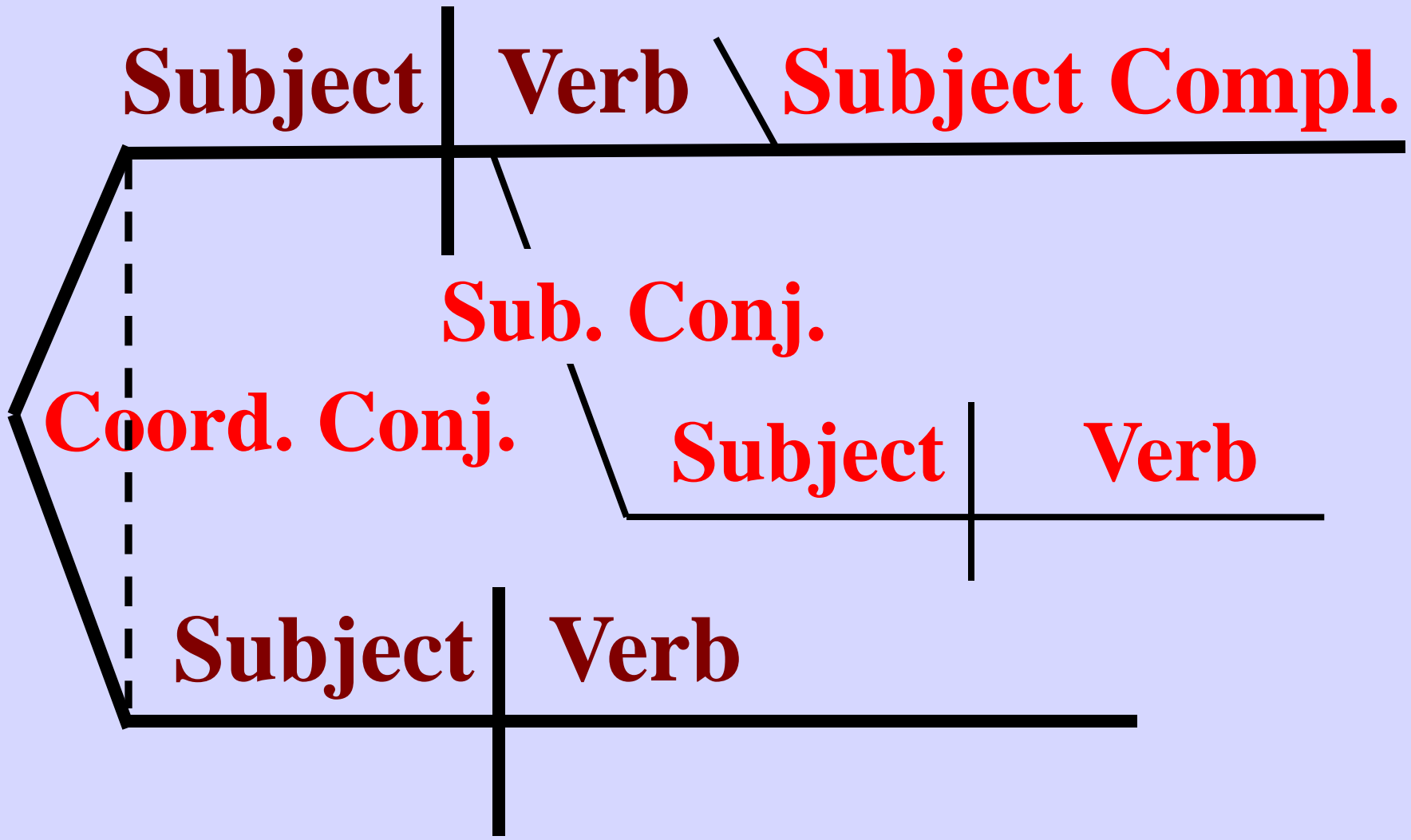

Vocative



Subject

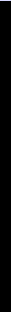

Verb



Main Clause

Antecedent

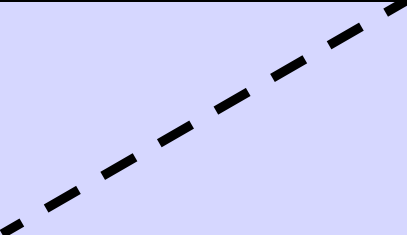

Relative Pronoun



Subject Clause

Verb Clause

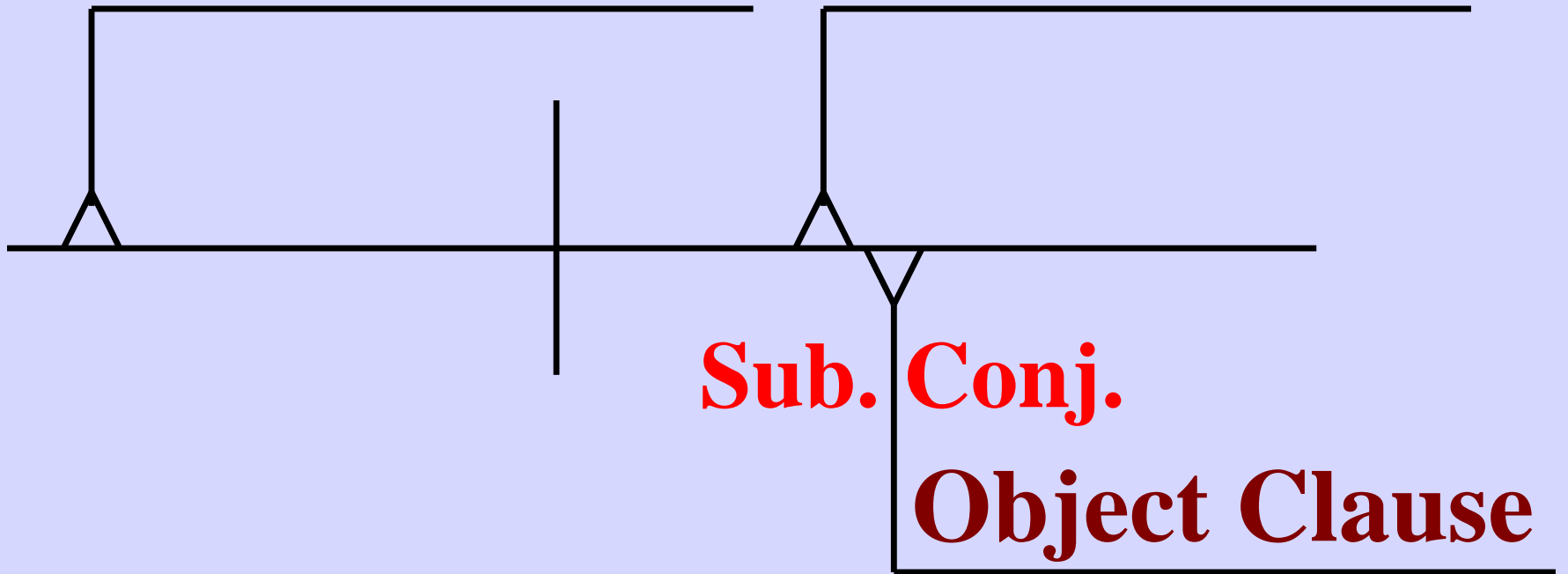

Every Word Has its Place



DIAGRAMMING

- 1. Reveals Grammatical Structure**
- 2. Forces decisions for every word**
- 3. Basic work sheet for all analysis**
- 4. Brings analysis & synthesis together**
- 5. Basis for exegetical outline**

Eph 4:11-13 And He gave some as apostles, and some as prophets, and some as evangelists, and some as pastors and teachers, **12** for the equipping of the saints for the work of service, to the building up of the body of Christ; **13** until we all attain to the unity of the faith, and of the knowledge of the Son of God, to a mature man, to the measure of the stature which belongs to the fullness of Christ. **14** ...

Eph 4:11-13 And **He gave** some as apostles, and some as prophets, and some as evangelists, and some as pastors and teachers, **12** for the equipping of the saints for the work of service, to the building up of the body of Christ; **13** until **we all attain** to the unity of the faith, and of the knowledge of the Son of God, to a mature man, to the measure of the stature **which belongs** to the fullness of Christ. **14** ...

Eph 4:11-16

And

4:11

He

Gave

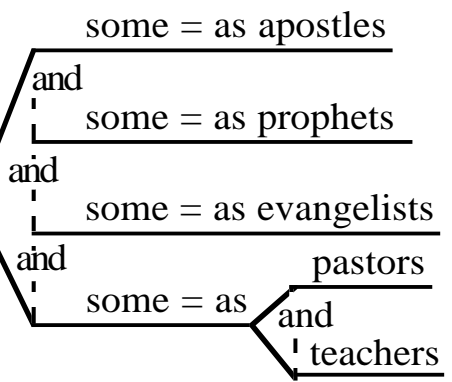

Eph 4:11-13 And He gave some as apostles, and some as prophets, and some as evangelists, and some as pastors and teachers, **12** for the equipping of the saints for the work of service, to the building up of the body of Christ; **13** until we all attain to the unity of the faith, and of the knowledge of the Son of God, to a mature man, to the measure of the stature which belongs to the fullness of Christ. **14** ...

Eph 4:11-16

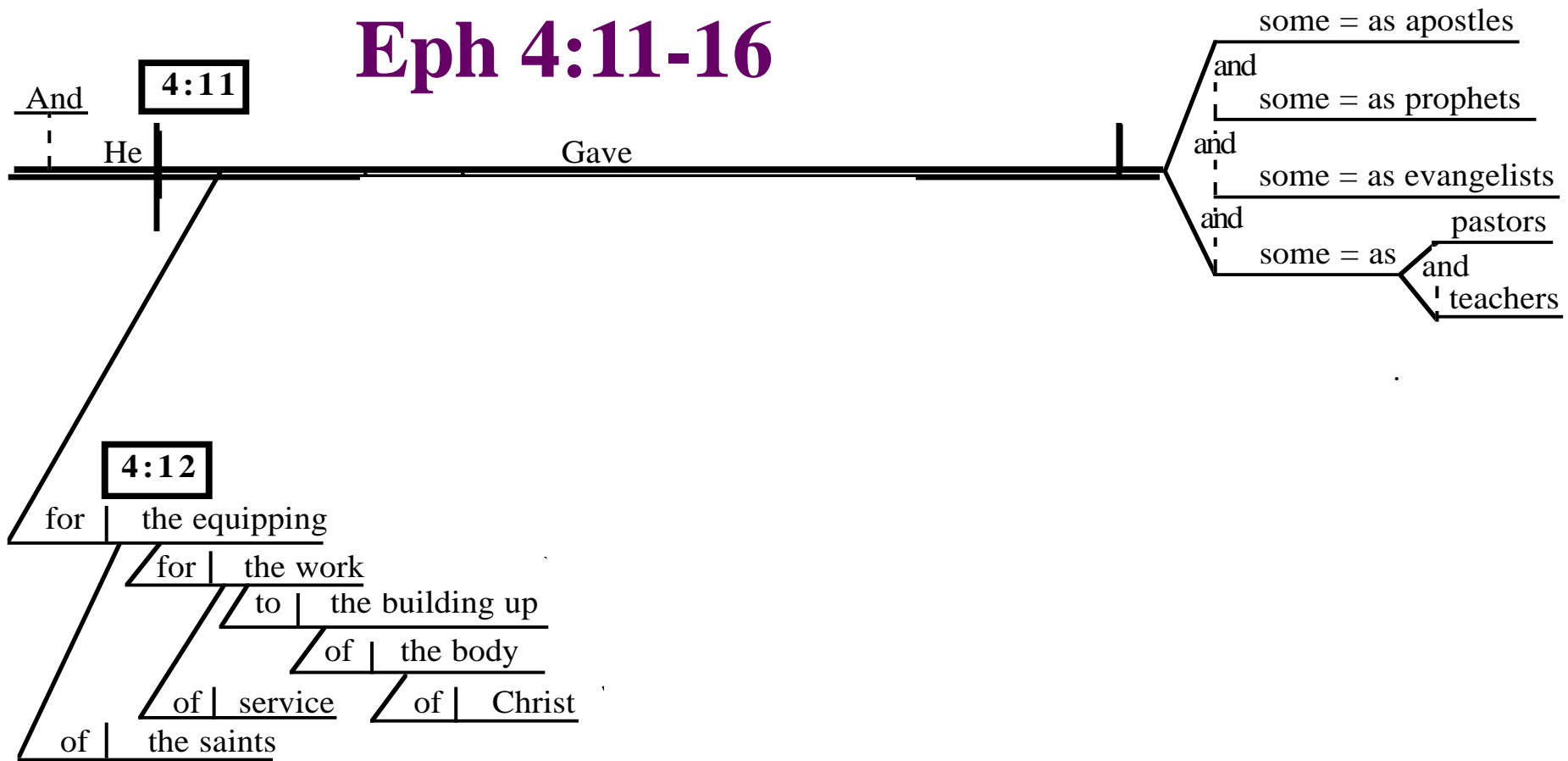

Sequential

Parallel

for | the equipping

of | the saints

for | the work

of | service

to | the building up

of | the body

of | Christ

Eph 4:11-13 And He gave some as apostles, and some as prophets, and some as evangelists, and some as pastors and teachers, 12 for the equipping of the saints for the work of service, to the building up of the body of Christ; 13 until **we** all **attain** to the unity of the faith, and of the knowledge of the Son of God, to a mature man, to the measure of the stature which belongs to the fullness of Christ. 14 ...

Eph 4:11-16

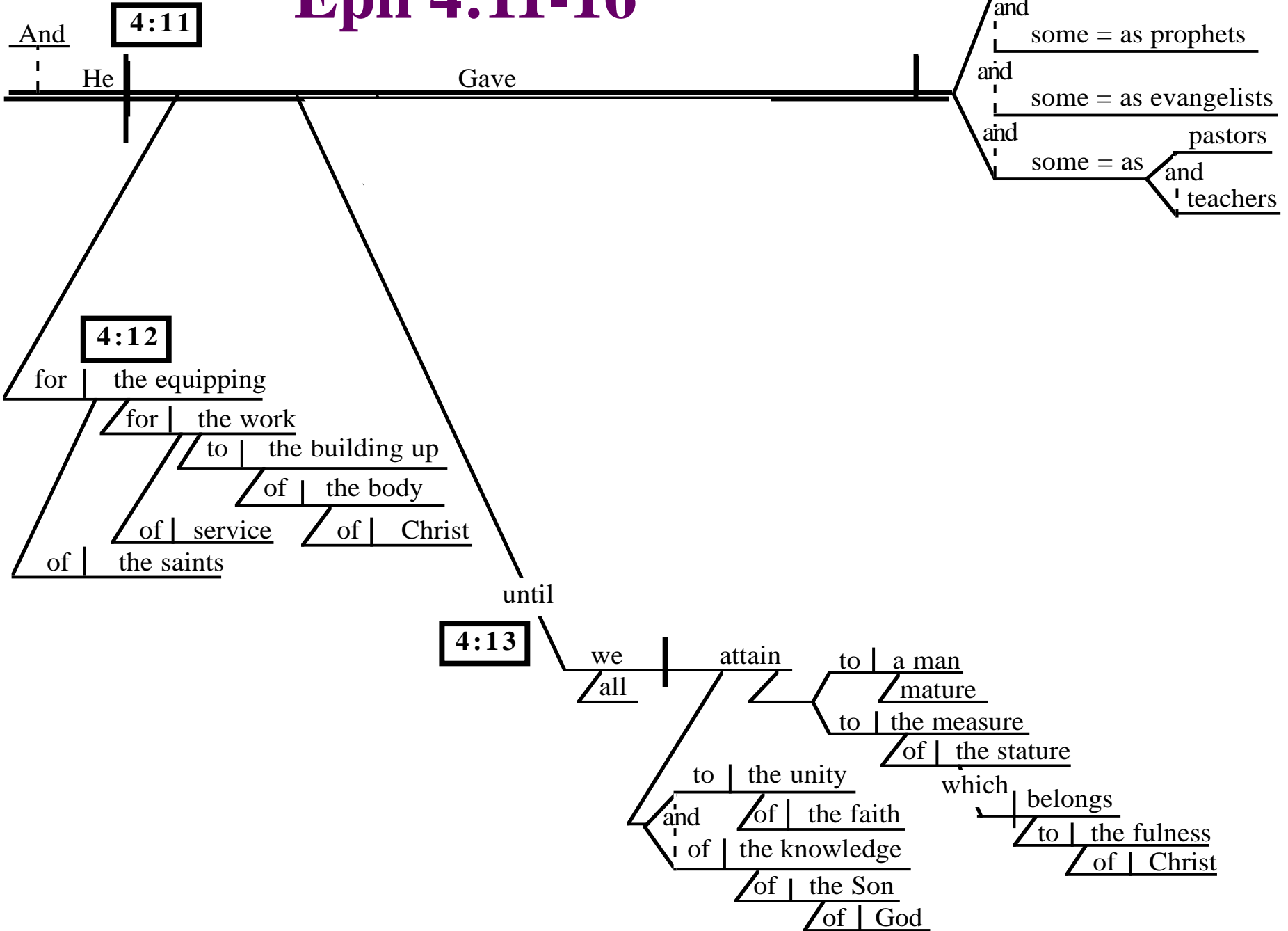

Eph 4:14-16 ... 14 As a result, we are no longer to be children, tossed here and there by waves and carried about by every wind of doctrine, by the trickery of men, by craftiness in deceitful scheming; 15 but speaking the truth in love, we are to grow up in all aspects into Him who is the head, even Christ, 16 from whom the whole body, ...

Eph 4:14-16 ... 14 As a result, we are no longer to be children, tossed here and there by waves and carried about by every wind of doctrine, by the trickery of men, by craftiness in deceitful scheming; 15 but speaking the truth in love, we are to grow up in all aspects into Him who is the head, even Christ, 16 from whom the whole body, ...

Eph 4:11-16

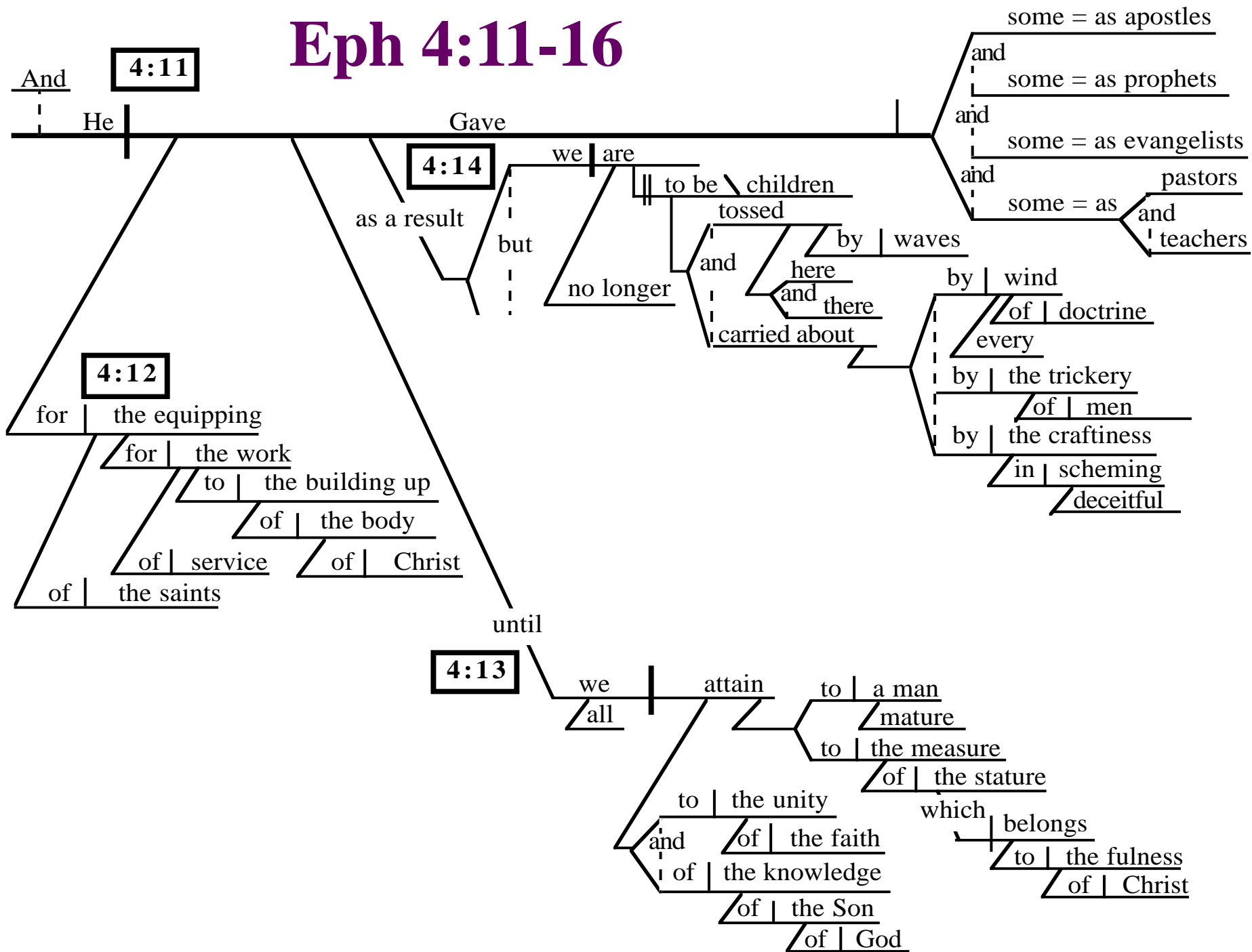

Eph 4:11-16

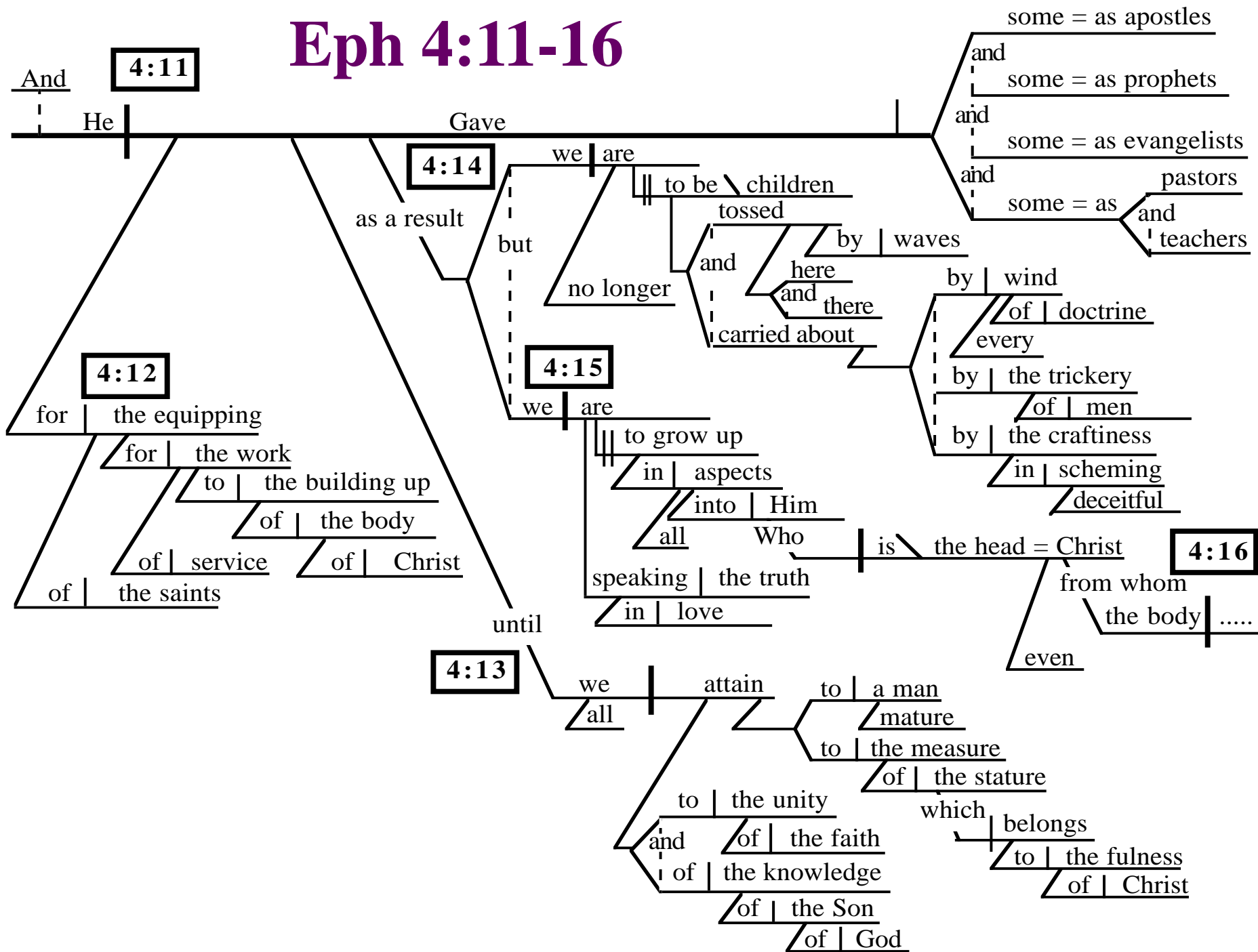

Act 1:7-8 He said to them, “It is not for you to know times or epochs which the Father has fixed by His own authority; 8 but you will receive power when the Holy Spirit has come upon you; and you shall be My witnesses both in Jerusalem, and in all Judea and Samaria, and even to the remotest part of the earth.”

Act 1:7-8 He said to them, “It is not for you to know times or epochs which the Father has fixed by His own authority; 8 but you will receive power when the Holy Spirit has come upon you; and you shall be My witnesses both in Jerusalem, and in all Judea and Samaria, and even to the remotest part of the earth.”

Act 1:7-8

1:7

He | said |
to | them

Act 1:7-8

1:7b

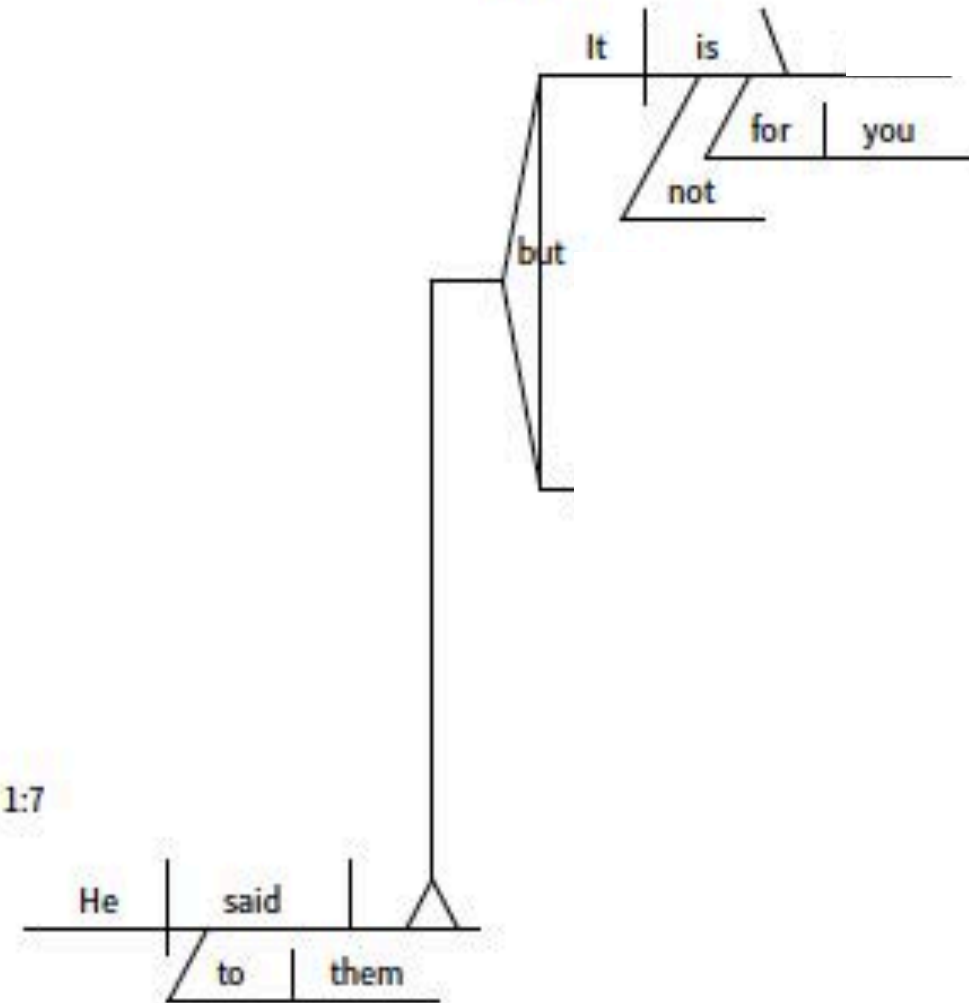

1:7

Act 1:7-8

1:7b

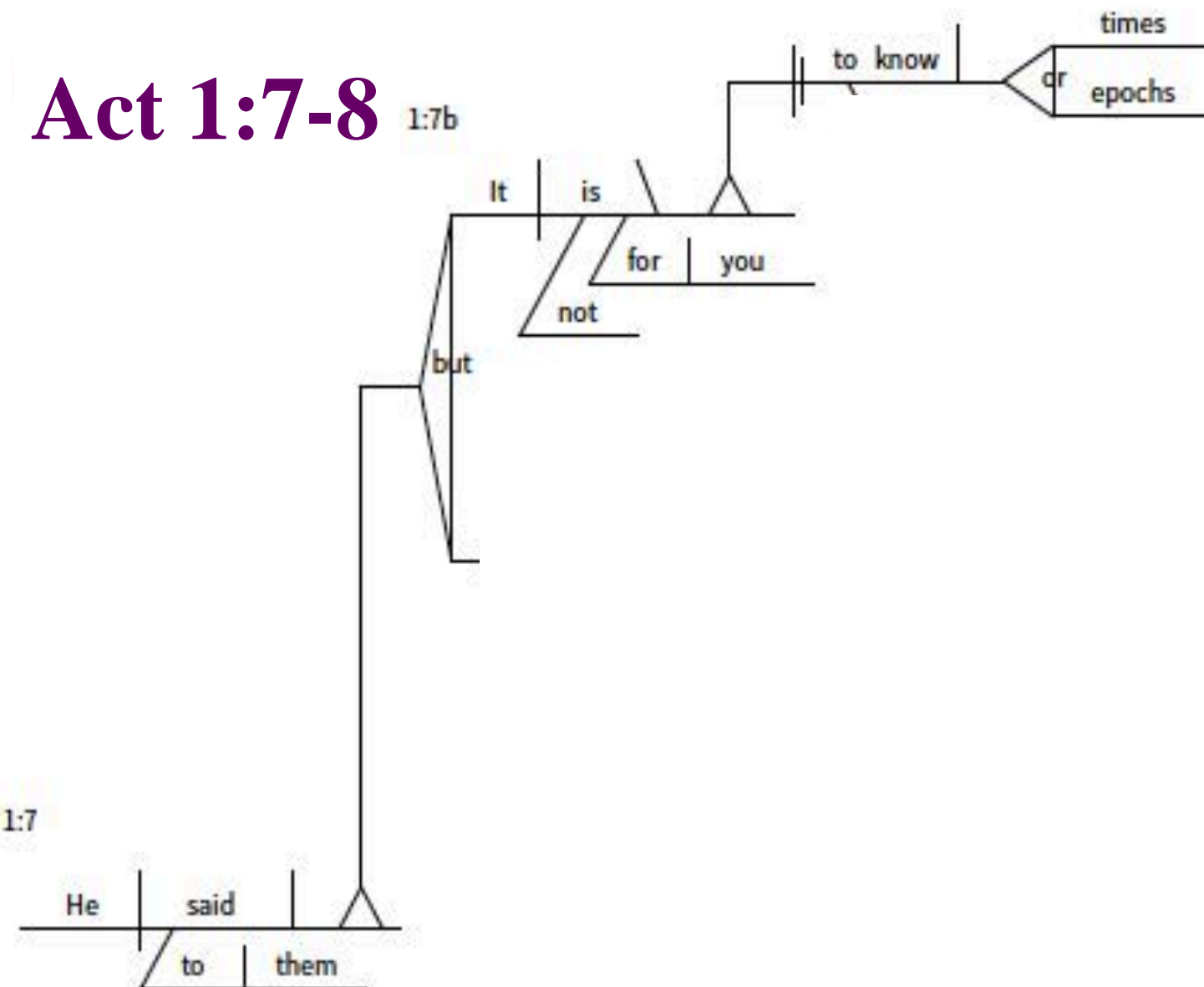

Act 1:7-8

1:7b

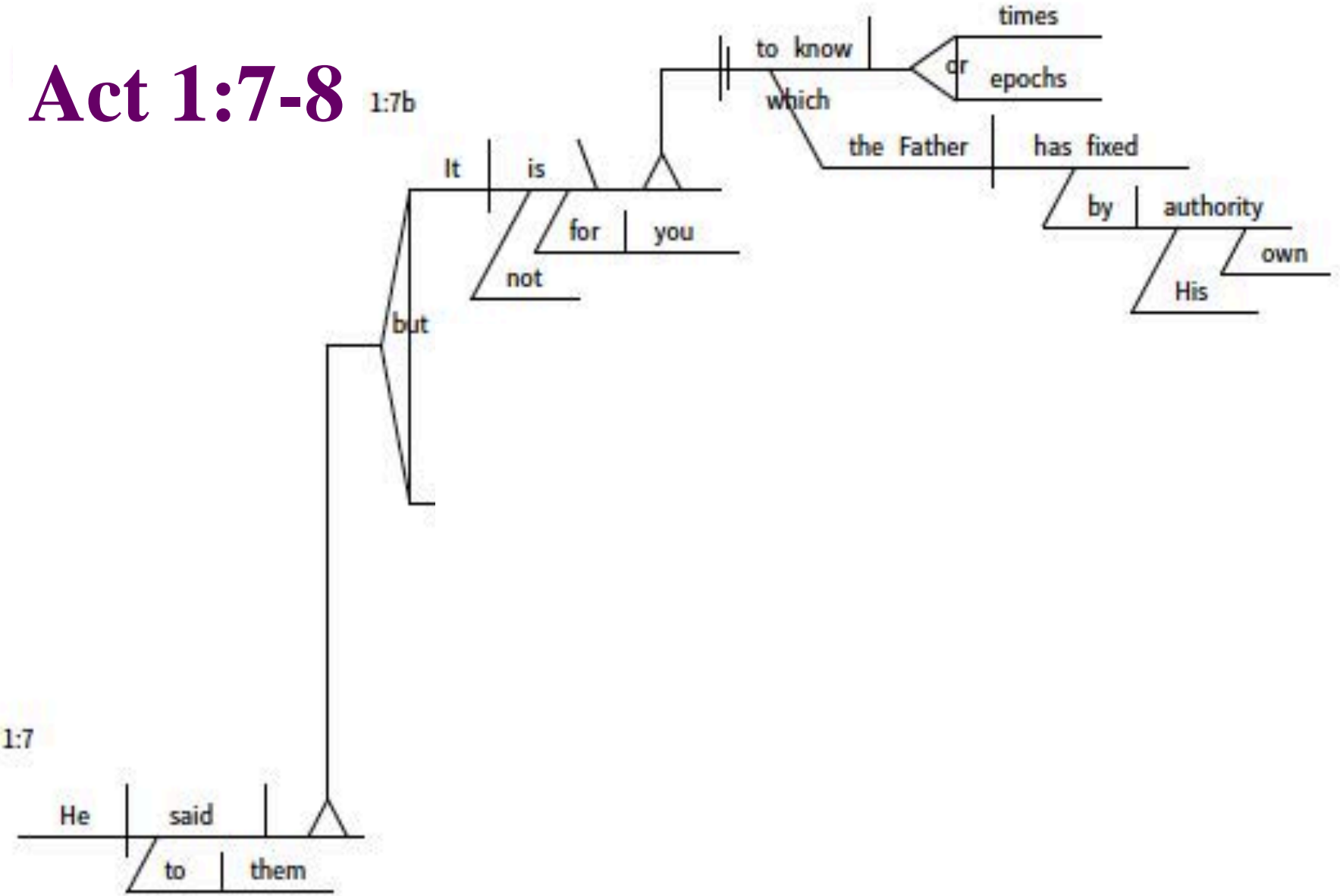

1:7

Act 1:7-8 He said to them, “It is not for you to know times or epochs which the Father has fixed by His own authority; 8 but you will receive power when the Holy Spirit has come upon you; and you shall be My witnesses both in Jerusalem, and in all Judea and Samaria, and even to the remotest part of the earth.”

Act 1:7-8

1:7b

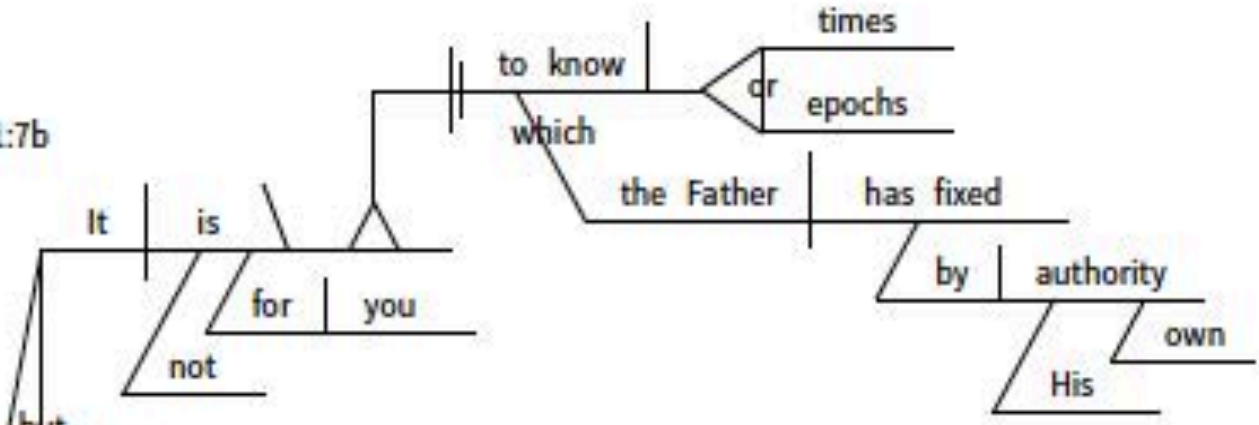

but

1:8



1:7

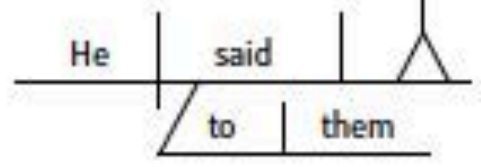

Act 1:7-8

1:7b

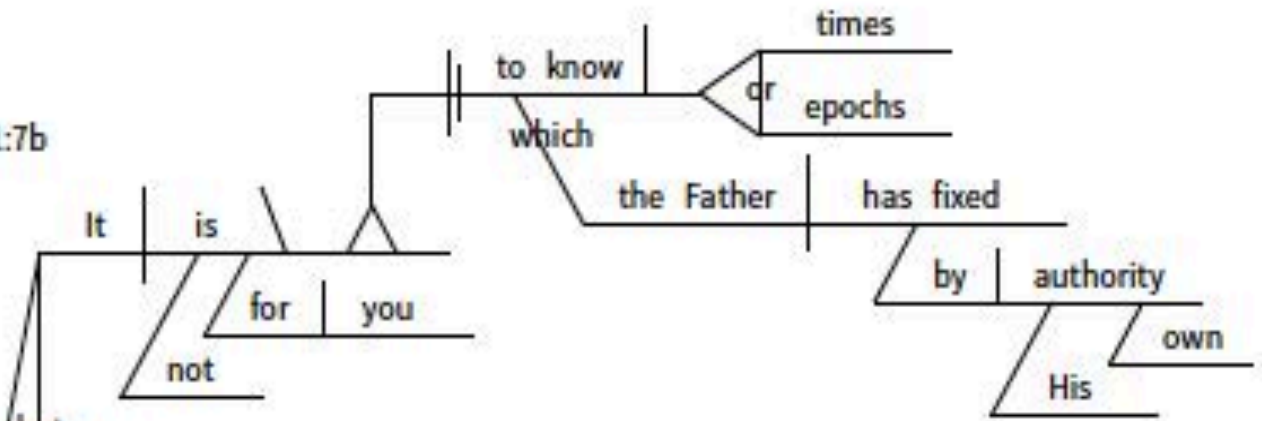

but

1:8

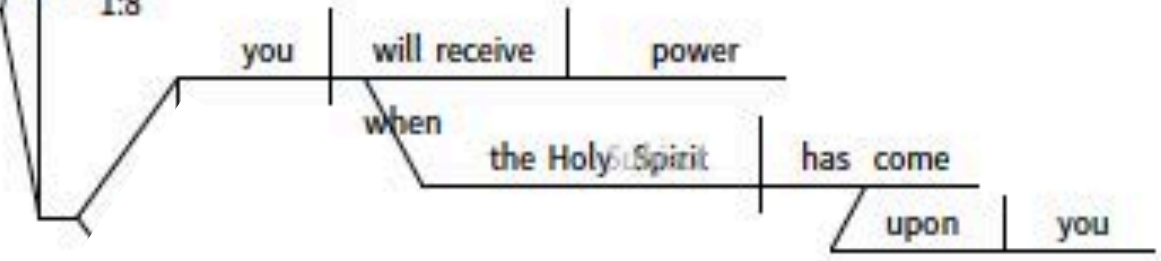

1:7

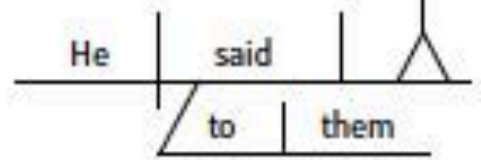

Act 1:7-8

1:7b

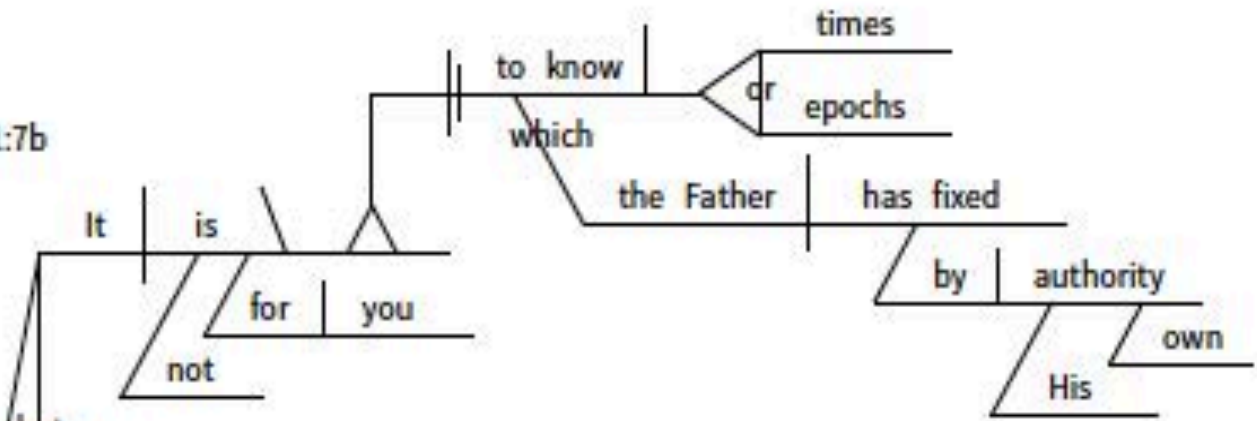

but 1:8

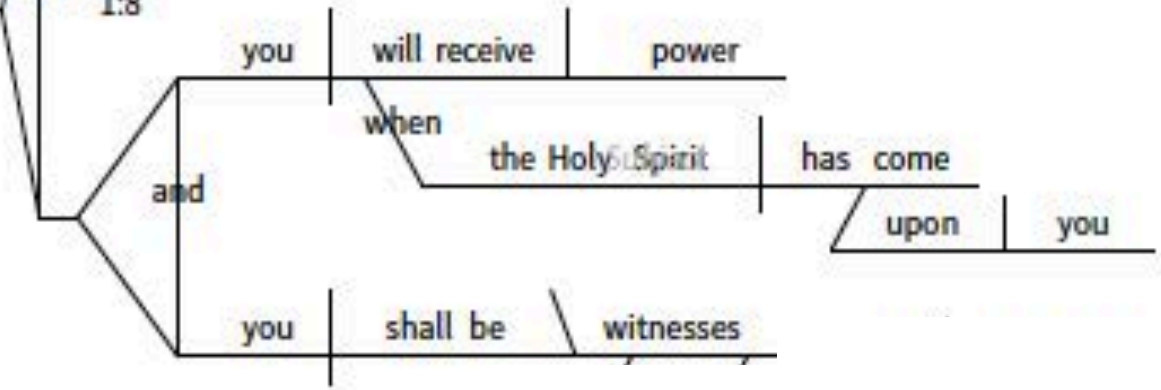

1:7

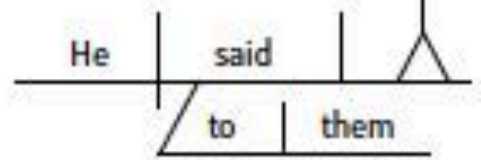

Act 1:7-8

1:7b

but

1:8

1:7

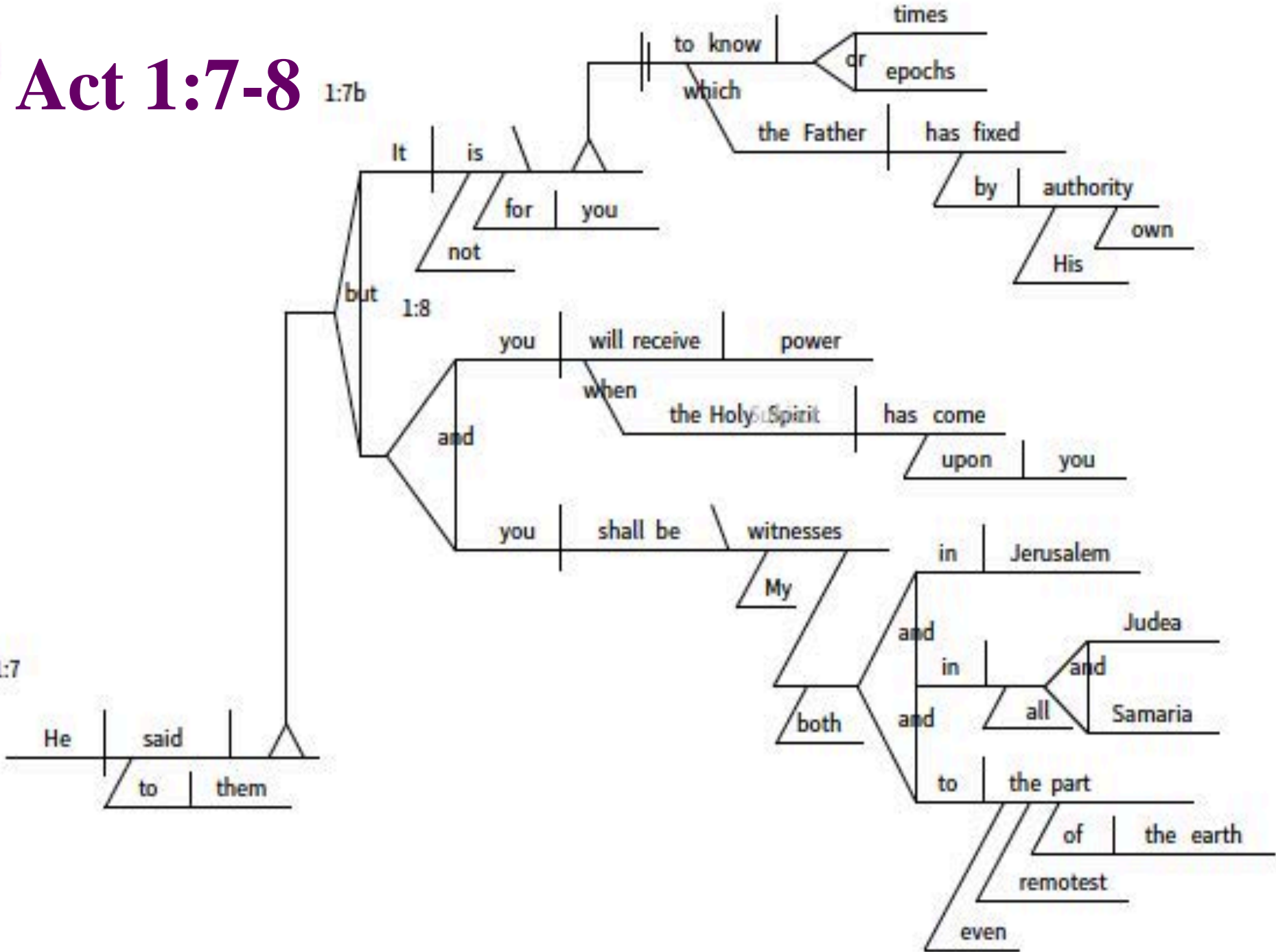

OUTLINE

- **Grammar Dictates Outline**
- **Outline Reflects Structure**
- **Paragraphs -> Main Points**
- **Sentences or Clauses -> Sub Points**
- **Clauses or phrases -> Lesser Points**